

# ROCK KRAWLER S U S P E N S I O N

## INSTALLATION MANUAL

FOR

**ROCK KRAWLER SUSPENSION, INC.**

**JL/ JLU ADVENTURE, ULTIMATE ADVENTURE,  
ADVENTURE-X MID ARM SERIES**

**2023 1st EDITION  
03/24/2023**



# ROCK KRAWLER

S U S P E N S I O N

**Dear customer:** Thank you for purchasing the best system on the market for your Jeep Vehicle. We are sure you will be happy with this system after your installation is complete. Please take your time during the installation and be sure to do it correctly. Completely read the directions before starting your installation so you know what to expect. Remember, your personal safety depends on it. Should you have any questions during this installation feel free to give our tech line a call and we will be happy to help you. (518-270-9822)

## Welcome to TEAM RK

Share your before & after pictures, install photos & wheeling images.

facebook



@RKSuspension

Instagram

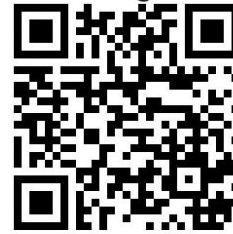

@rock\_krawler

**Note: BE SURE TO CHECK ALL FASTENERS FOR PROPER TORQUE BEFORE TEST DRIVE. RECHECK AFTER 500 MILES AND BE SURE TO CHECK PERIODICALLY.**

### WARNING

- Properly block and secure vehicle prior to installation.
- Always wear safety glasses when using power tools.
- Rock Krawler Suspension recommends the use of Loctite on all hardware, unless noted otherwise.
- The use of limiting straps is recommended to avoid damage from overextending the suspension of your vehicle.
- Read and understand all instructions, warnings and safety precautions in these instructions and your owner's manual before attempting to install these components.
- Proper installation of Rock Krawler Suspension products requires knowledge of recommended procedures for disassembly/assembly of OE vehicles and components. Access to OE shop manuals and special tools are required. Attempting to install this kit without knowledge of these procedures may affect the safety of your vehicle and or the performance of these components. Rock Krawler Suspension, Inc. strongly recommends that this system be installed by a certified mechanic with off road experience.
- Rock Krawler Suspension does not recommend combined use of suspension lifts, body lifts or other lift devices. Combined use of lifts may result in unsafe and unexpected handling characteristics. Also, many states now have laws restricting Vehicle lift, bumper heights, and other alterations. Consult local laws to determine if your proposed alterations (including installation of this system) comply with your state laws.
- Rock Krawler Suspension does not condone or authorize the use of any other suspension components with its products. Should Rock Krawler Systems or components be installed in junction with other products or not per the provided instructions Rock Krawler Suspension warranty is void and is not to be held accountable for any resulting actions.

# ROCK KRAWLER

S U S P E N S I O N

## Driving and Handling Tips

- For Highway driving it is best to have the front sway bar connected. This will give you the on-highway ride and handling characteristics you expect. **If you choose otherwise, you do so at your own risk.**
- The ride quality and handling that Rock Krawler is known for is based on using OEM sway bars front and rear with approved shocks. Using any components other than directed can result in adverse handling characteristics and poor ride quality.
- For Off-Road use it is best to have the front sway bar disconnected and the rear sway bar connected. This will allow your suspension to do its intended function. Our suspension will give your vehicle unmatched articulation which will provide traction and feedback to keep your vehicle moving in almost all conditions. Let the suspension do the work! Even if you are a Rubicon Owner for most situations, we recommend manually disconnecting the front sway bar.

## IMPORTANCE OF JAM NUTS

**This is a note about jam nuts and the consumer's responsibility. The installer is the person or persons initially responsible for the proper setup of the suspension system and/or components and the initial tightening of the jam nuts. The jam nuts not only hold the orientation of the joint it is on, but it is the single component that puts the necessary pre-load on the joint's threads. The consumer or vehicle owner is the person or persons responsible for maintaining the jam nuts tightness. Failure to do so will result in the rapid deterioration of the threads in the control arm and will impose a "cause for concern" for the occupants of the vehicle. Failure to comply with the warnings heeded in the directions regarding the number of threads showing past the jam nut will also result in the same "cause for concern" for the occupants of the vehicle. All of the above items are the responsibility of the vehicle owner and or installer. If a threaded section of a component is bad it will show itself defective immediately. Threads that fail over time are due to improper maintenance of jam nuts and can be proven very easily. Thread sections and jam nuts not properly maintained or setup, are not covered under warranty. This is the end user and installer's responsibility.**

## ORIENTATION OF JOINTS

Orient the Joint for maximum amount of movement with the head of joint perpendicular to bolt / head of the joint vertical in the mounting bracket. This same rule for orientation needs to be followed for all heim joints. The photo below shows the right way (LEFT SIDE) and the wrong way (RIGHT SIDE) to orient a joint.

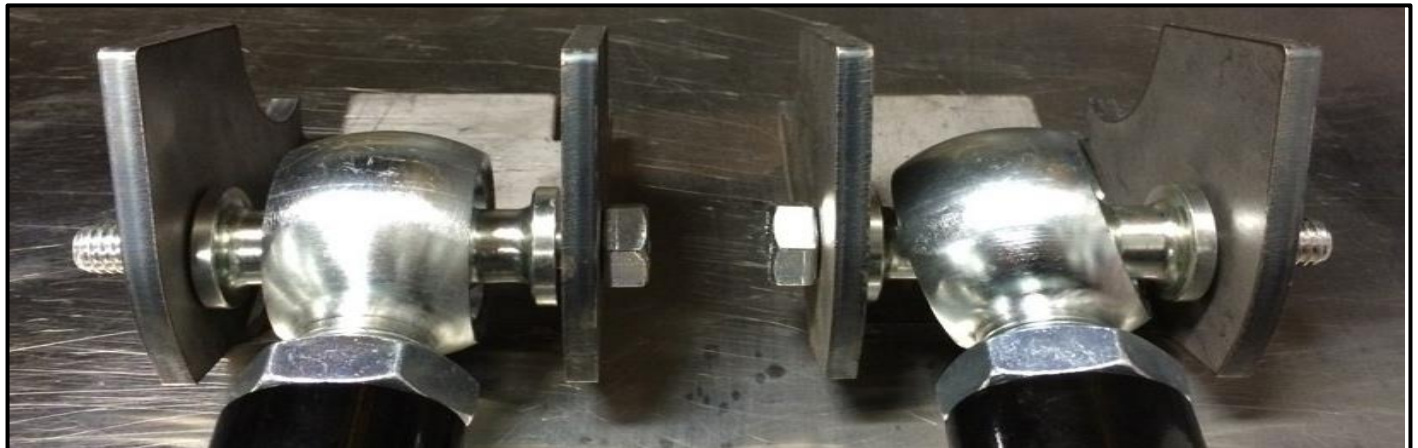

**^RIGHT WAY^**

**^WRONG WAY^**



## MAINTAINING JOINTS

### Krawler Joints/Pro Flex Joints, Anti-Wobble Joints, and Pro Disconnect Joints

**Before Jan 1, 2020,** The Pro Series Krawler Joints, Pro Flex Joints, Anti-Wobble Joints and Pro Disconnect Joints are greaseable. They come pre-greased from the factory. The grease valley is machined into the housings. We require Triple Zero (000) grade grease for lubrication of all our joints. They will not take a lot of grease, nor do they need a lot of grease. Approximately every 4 to 6 months under normal operating conditions they should be greased. This is condition and use dependent so please use common sense. Over lubrication or using the incorrect grade of grease can do damage to the joints and hydraulically displace the race way material causing a sloppy joint condition. Never ever use red and tacky.

**After Jan 1, 2020,** The Pro Series Krawler Joints, Pro Flex Joints, Anti-Wobble Joints and Pro Disconnect Joints are greaseable. They come pre-lubed from the factory. The grease valley is machined into the housings. Grade 1 grease can be used in all joints. They will not take a lot of grease, nor do they need a lot of grease. Approximately every 4 to 6 months under normal operating conditions they should be greased. This is condition and use dependent so please use common sense. Over lubrication or using the incorrect grade of grease can do damage to the joints and hydraulically displace the race way material causing a sloppy joint condition. Never ever use red and tacky.

If the joint is not loose, it is not bad. Only if the ball is sloppy in the joint housing is it a bad joint and should be rebuilt. Krawler Joint Raceways, Pro Flex Joint Raceway, or Anti-Wobble Joint Raceways are available through Rock Krawler Suspension or an authorized dealer.

Please note: If you are not using the full range of motion of the Krawler Joint, Pro Flex Joint, or Anti-Wobble Joint very often, the lubrication will not be moving inside the joint. In such cases we recommend spraying down the outside of the Joint with WD-40 or Liquid Fluid Film to ensure the race ways do not dry up. In highly corrosive environments it is also recommended to spray down the suspension components with WD-40 or Liquid Fluid Film. This will minimize corrosion of the components due to exposure to the elements.

### HEIM JOINTS (Non- rebuildable spherical joints)

All Rock Krawler Heim Joints use Teflon Liners and thus are self-lubricating. They too can also benefit from spraying down the outside of them liberally with WD-40 or Liquid Fluid Film. Grease should never be applied to them! Take caution when using cleaners and detergents on your vehicle as it can ruin the adhesives used on the Teflon liners yielding a bad heim joint!

## SUGGESTED STARTING LENGTHS

Measured from Bolt hole to Bolt hole in a straight line not along the bar

### Front Track Bar (RK06187HD)

2.5" lift – 34 3/16"  
3.5" lift – 34 5/16"  
4.5" lift – 34 7/16"

### Rear Track Bar (RK06692B)

2.5" lift (w/ bracket) – 37 9/16"  
3.5" lift (w/ bracket) – 37 11/16"  
4.5" lift (w/ bracket) – 37 13/16"

### Front Lower Control Arms (AS-RK06779B Fixed) (AX-RK08194)

2.5" lift heights – 24 1/4"  
3.5" lift heights – 24 5/8"  
4.5" lift heights – 24 11/16"

### Front Upper Control Arms (RK07848)

2.5" lift heights – 20 7/16"  
3.5" lift heights – 20 9/16"  
4.5" lift heights – 20 5/8"

### Rear Lower Control Arms (AS-RK06063B Fixed) (AX-RK08195)

2.5" lift heights – 20 1/4"  
3.5" lift heights – 20 5/16"  
4.5" lift heights – 20 3/8"

### Rear Upper Control Arms (RK07850)

2.5" lift heights – 17 9/16"  
3.5" lift heights – 17 5/8"  
4.5" lift heights – 17 11/16"

# ROCK KRAWLER

## S U S P E N S I O N

***\*Please Note:*** All Control Arms, Track Bars, and Sway Bar Links come preassembled, but require adjustment to the above recommended starting dimensions. These measurements are taken from the center of one bolt hole to center of the other bolt hole. **Please check out our Rock Krawler YouTube Channel if need be, for how to set the control arms properly and the importance of Jam Nuts...**



## **TORQUE VALUES FOR HARDWARE AND JAM NUTS**

- All 10mm and 3/8 bolts are torqued to 30-35 ft-lbs.
- All 12mm and 1/2" bolts are torqued to 75-80 ft-lbs.
- All 14mm and 9/16" bolts are torqued to 90-100 ft-lbs.
- All 16mm and 5/8" bolts are torqued to 120-140 ft-lbs.
- All 7/8" Jam Nuts are to be torqued 200-220 ft-lbs. Up to 5/8" of threads showing past the jam nut is safe for final adjustment. These specifications are critical for the overall longevity of the threaded section.
- All 1" Jam Nuts are to be torqued to 250-300 ft-lbs. GET YOUR BIG BOY PANTS ON! Up to 3/4" of threads showing past the jam nut is safe for final adjustment. These specifications are critical for the overall longevity of the threaded section.
- All 1 1/4" Jam Nuts are to be torqued to 275-325 ft-lbs. GET YOUR BIG BOY PANTS ON! Up to 7/8" of threads showing past the jam nut is safe for final adjustment. These specifications are critical for the overall longevity of the threaded section.

## **FRONT OF VEHICLE (Perform all Steps for the System you are installing)**

- 1) If you are using a floor jack and jack stands, make sure vehicle is on a hard, level, working surface, then, block the rear wheels so the vehicle cannot move and make sure the emergency brake is applied.
- 2) Raise the front of vehicle. Support with safety jack stands. Locate jack stands on the frame in front of the axle. If you are using a vehicle lift, place the lift arms according to those specific vehicles lifting procedures. Ensure that the lift arms will not interfere with the components that are being replaced.
- 3) Lower the front axle assembly onto jack stands.
- 4) Do not overextend the front drive shaft. Disconnect front driveshaft from axle and mark holes to reassemble in the same orientation if needed. Secure out of the way.
- 5) For all OEM components being reused, loosen the mounting hardware at all connections so you do not overstress the OEM vulcanized rubber bushings. Failure to do so can result in a rougher than expected ride, adverse handling, and premature wear of the OEM components.
- 6) Remove the front wheels and tires.
- 7) Remove the front shocks. Save the OEM upper hardware to install the new shocks.

# ROCK KRAWLER

S U S P E N S I O N

- 8) Remove the front sway bar links, save hardware and discard.
- 9) Remove the nut holding the factory brake line to the OEM lower control arms. Clip the ties holding the pass. side disconnect motor cable from the passenger side front upper control arm and disconnect motor housing. Be sure to add slack to the breather tube. Remove the metal bracket that held the factory brake line to the control arm from the brake line itself by prying it off the line or gently cutting it off. This will provide you with more than enough extra brake line slack. All are shown below.

*Helpful hint: use 2 pair of vice grips, one pair to hold the bracket and one pair to peel the bracket back off the line.*



**Remove Brake Lines from Arms**



**Clip for Breather Line Slack**



**Remove the plastic clips holding the pass. disconnect motor cable from the upper arm and motor housing as shown.**

- 10) Remove the front track bar from the vehicle and save the OEM hardware for reuse.
- 11) Remove the front springs as well as the OEM bottom Spring seats and discard all.
- 12) Remove the front lower control arms, discard, and save the OEM hardware for reuse.
- 13) **For All Systems Other Than the Adventure system:** Remove the front upper control arms, discard, and save the OEM hardware for reuse.

# ROCK KRAWLER

S U S P E N S I O N

- 14) For the **3.5"** and **Taller Systems**, the drag link end will be your limiting factor without shocks to allow the axle to droop. For these systems, we recommend you separate the drag link from the knuckle connection to allow for ease of axle movement. Shown on side.



- 15) If you have long shocks where the control arms contact the stock lower control arm mounts, we recommend you cut a little relief in the Lower control arm mount as shown. Otherwise, skip this step. Helpful Hint: a 2.5" hole saw is a simple way to make a nice, clean cut. Then add some paint of your choice to minimize rust later on. (Shown below)



- 16) If you received or purchased separately the Rock Krawler front stackable bump stops, now is a great time to drill the lower bump stop pad with a  $\frac{1}{2}$ " drill bit to make installation of the stackable bump stops easy. We recommend 2 pads for 2.5" of lift, 3 pads for 3.5" of lift and 4 pads for 4.5" of lift. Choose the proper  $\frac{1}{2}$ " bolt.

# ROCK KRAWLER

S U S P E N S I O N



- 17) Install the supplied Rock Krawler spring seats. They are not side specific and use the locating pin on the axle to set their orientation. Please see below.



**New Bottom Spring Seats Shown with Bump Stop Stack in Place**

- 18) **Adventure-X and Ultimate Adventure Systems:** Install the supplied front upper control arms set to the specified length for your kit according to our measurements. Secure using the OEM hardware. Be sure to rewrap the OEM heat shielding products after installation is supplied on your vehicle. The bend in the upper arms are designed for frame clearance and go down and away from the frame.



# ROCK KRAWLER

S U S P E N S I O N



**Pass. Side Front Upper Showing Clevis Adjuster at the Axle Connection. Remember, the bend in the arm goes down and away from the frame (Not Up)**

- 19) Install the front lower control arms set to the specified length for your kit according to our measurements using the OEM hardware. **For Adventure and Ultimate Adventure:** The arms are fixed length and non-directional. The bend in the arm are for improved ground clearance and goes up.

**\*Please Note:** For Adventure X, the fixed Adventure Joint goes to the axle and the adjustable Adventure Joint goes to the frame.



**Frame Side**

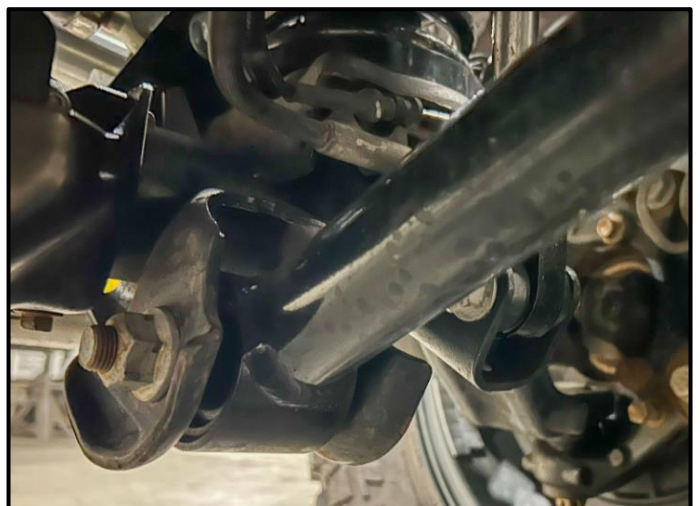

**Axle Side**

- 20) Install the supplied front coil springs with OEM upper isolators on top and Rock Krawler front spring correction pad on the bottom. (RK06705K) Make sure the bottom winding of the coil butts up against the stop in the new bottom spring seat and the top winding is properly centered using the OEM spring pad on the frame. If the coil is not seated properly, it will bow more than it should and can damage your coil. If the coil is still bowing, you may have to rotate upper isolator. Call our office for directive. 518-270-9822

# ROCK KRAWLER

S U S P E N S I O N

**NOTE: CUSTOMERS WITH COIL OVER KITS – PLEASE SEE THE COIL OVER SUPPLEMENT AT THE END OF THE INSTRUCTIONS.**

21) Install the front shocks using OEM hardware.

**Note:** *If your OEM shock bolt runs into the control arms, swap them with the rear sway bar link top bolts.*

- a) If you purchased the RRD 2.25 shocks, you'll notice that the front shocks have offset ends, both top and bottom, this should be installed to push the shock body away from the frame, to avoid interference between the frame and shock. You might need to swap the bushing and sleeve insert with the one supplied with RRD shock if shock came assembled differently. The Schrader valve should be installed so that it is pointing towards the rear of the Jeep. **Please note:** RRD 2.25 shocks require recharging at certain intervals. They need to be 100 PSI at full extension. They may need to be removed from vehicle to charge properly. Nitrogen performs the best, compressed air is forbidden.
  - b) If you purchased our TT shocks, you should position the bushings to push the top mount as far from the frame as possible.
  - c) If you are using any other aftermarket shock or shock extension, look to that manufacturer for guidance.
- 22) As you are compressing the suspension, install the front track bar reusing the OEM hardware. Be sure to set it to the starting dimensions for your system as specified above. The rebuildable Anti-Wobble joint goes to the frame connection and the heim joint with high misalignment spacers go to the axle connection as shown below.

**Helpful hint:** Be sure to have the steering column unlocked so the axle will swing side to side freely.



**Frame Side**



**Axle Side**

- 23) Reattach the drag link to the passenger side knuckle.
- 24) Choose your front sway bar link package: Gen 2 Disconnects or No Limits Links (Rubicon Models). For Gen 2 Disconnects follow steps A and B. For No Limits Links follow step C only. **If you only received fixed links in your system relocate the rear sway bar links to the front.**

A) For **Gen 2** Sway Bar Disconnects.

**Recommended Starting Lengths: 2.5 Systems 9" | 3.5" Systems 9.5" | 4.5" Systems 9.75"**

- A.1) For the **Driver** and **Passenger Side Top**: The Offset Spacer with the Disconnect Pin goes against the sway bar and is secured with a 1/2" washer and 1/2" nylok nut. Orient the Disconnect Pin so the lynch pin goes in vertically.
- A.2) For the **Driver side Lower**: The bottom disconnect pin gets secured to the outside of stock sway bar link mounting tab with a 1/2" washer and 1/2" Nylok Nut. The bottom can be oriented in any direction you find easiest to remove the lynch pin.
- A.3) For the **Passenger side Lower**: Starting from the inside of the track bar mount. Tighten into the coupling nut the 1/2" bolt with 1/2" washer by holding the coupling nut and tightening the bolt. You may elect to use locktite at this time.

# ROCK KRAWLER

S U S P E N S I O N

A.4) Continuing on the **Passenger side Lower**: The bottom disconnect pin threads into the stainless-steel coupling nut. While holding the coupling nut tighten the disconnect pin. You may elect to use locktite at this time.

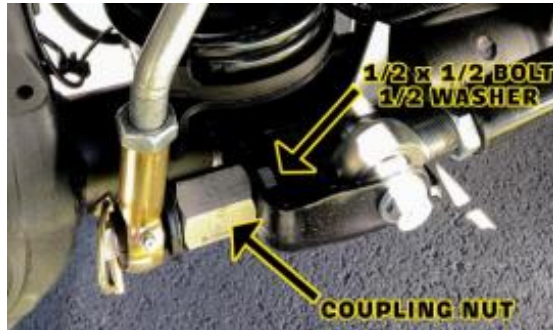

*Please note:* An extra 1/2 washer and nylok nut is included for the passenger side lower mount for aftermarket axle housings that will not support the coupling nut like the OEM housings do.

A.5) Slide the sway bar links on the disconnect pins top and bottom and insert lynch pins.

*Helpful Hint:* lubricate the pins with WD40 or Liquid Fluid Film to make them easier to slide on and off the stainless steel disconnect pins.

*Please Note:* When locking the jam nuts, the offset in the sway bar link pin is to the outside of the vehicle. Some aftermarket axle housings may not line up exactly like the OEM housings so you can rotate the center link to a front and back offset on those housings as needed.

B. To install your sway bar link straps use the supplied 5/16" Bolt, Washers, and Nut to attach them as shown to the coil spring bucket. Or you can drill a hole in a more preferred place of your liking.



**Sway bar strap retainer installed**

# ROCK KRAWLER

S U S P E N S I O N

C.1) For No Limits Links: Set your sway bar links to the lengths below based on lift height. Torque the jam nuts to 60-75 ft-lbs. with the joints in line with one another. This can be done in the vehicle.

**Recommended Starting Lengths**    **2.5" Systems – 10" / 3.5" Systems – 11.25" / 4.5" Systems -12"**



**Passenger's side connection shown**

C.2) Start with the side of your choice – Use the supplied 12mm x 70mm bolts, four washers and locknut for each side. Refer to the images above for the orientation of hardware. One washer connects the head of the bolt, that bolt goes through the sway bar link and through the sway bar hole. Then attach another washer followed by a locknut. Torque the two 12mm bolts to a value of 75-80 ft-lbs.

25) If disconnected, reinstall front driveshaft in the same position it was originally for balance.

26) Tighten all connections per the recommended torque specs above.

27) Put the tires and wheels back on the front end and carefully lower the vehicle to the ground.

# ROCK KRAWLER

S U S P E N S I O N

## **REAR OF VEHICLE (Perform all Steps for the System You Are Installing)**

- 1) If you are using a floor jack and jack stands, make sure vehicle is on a hard, level, working surface, then, block the rear wheels so the vehicle cannot move and make sure the emergency brake is applied.
- 2) Raise the rear of vehicle. Support with safety jack stands. Locate jack stands on the frame behind the rear of the axle. If you are using a vehicle lift, place the lift arms according to those specific vehicles lifting procedures. Ensure that the lift arms will not interfere with the components that are being replaced.
- 3) Lower the rear axle assembly onto jack stands.
- 4) For all OEM components being reused; loosen the mounting hardware at all connections so you do not overstress the OEM vulcanized rubber bushings. Failure to do so can result in a rougher than expected ride, adverse handling, and premature wear of the OEM components.
- 5) Remove the rear wheels and tires.
- 6) Remove the rear shocks. Save the OEM hardware for reuse.
- 7) Remove the OEM rear sway bar links and discard them for they will not be reused.
- 8) **For Rubicon models only**, remove the electric locker line from the plastic clips holding it to the cross member as shown below to gain slack in the line.



**Remove E Locker Line from this connection point to add slack in the line.**

- 9) Disconnect the E Brake Cables from the axle and reroute them under the upper cross member instead of over the top and having them come down behind the cross member. This will gain you the necessary slack in the E Brake Cables as the axle droops down. Reattach them to the axle. Be sure to remove and discard the clip that holds the E brake Cables to the bottom of the floor.

**Please note:** On the 4XE there may not be enough room to route the lines under cross member so add slack by removing the bracket and checking for clearance.

# ROCK KRAWLER

S U S P E N S I O N



### E Brake Cables routed ahead of the cross member

- 10) Remove the rear coil springs and bottom spring seats and discard. **Note:** Retain one OEM seat if you have a 392.
- 11) Unbolt the axle end of the rear track bar, save it and the OEM hardware for reuse. If you purchased the optional rear adjustable track bar, remove the OEM rear track bar, and save the OEM hardware for reuse.
- 12) **All Systems Other Than the Adventure system:** Remove the rear upper control arms and save the OEM hardware for reuse.
- 13) **All Systems Other Than the Adventure system:** Remove the rear upper control arms and save the OEM hardware for reuse.
- 14) **For non XR and non 392 applications:** Install the rear track bar relocation bracket using the supplied 14mm x 90mm bolt, washers, nylok nut, the 7/8" O.D. x 9/16 I.D. x 1.625" long crush sleeve on the inside of the OEM lower track bar mount, and supplied 1/2" U-bolt, washers, and nylok nuts as shown below. Tightening sequence is as follows; with all the hardware in place, tighten the 1/2" nylok nuts on the U-bolt to 50-55 ft-lbs. Then tighten the OEM mounting bolt at the OEM location.



Crush Sleeve



14x90 bolt



1/2" U Bolt

# ROCK KRAWLER

## S U S P E N S I O N

- 15) **Adventure series skip this step:** Install the rear upper control arms set to the specified length for your lift height according to our measurements and secure using the OEM hardware.

*\*Please Note:* The arms can be installed in either direction, but it is much easier to get to the jam nut if you put the adjustable end at the frame connection as shown below.

- 16) **Adventure series skip this step:** Install the rear lower control arms set to the specified length for your kit according to our measurements using the OEM hardware. For Ultimate Adventure, the arms are fixed length and non-directional. The bend in the arm are for improved ground clearance and goes up.

*\*Please Note: For Adventure-X:* The fixed Adventure Joint goes to the axle and the adjustable Adventure Joint goes to the frame.



**Rear Upper and Rear Lower Installed in the Vehicle**

- 17) Install the spring seats on the axle. The thick part of the spring seats goes toward the rear of the vehicle. There is a specific driver and passenger side marked by a D and P on the bottom of the spring seats. The **passenger side is thicker** than the driver side on the **3.6L and 2.0 Turbo as well as the Diesel**. They key in on the OEM spring pad hole for proper orientation.

- **4XE Models use both of the Rock Krawler provided thick seats. The thin one is not used.**
- **392 Models use only a Thick Spring Seat on the passenger side rear. The Driver Side just uses the OEM spring seat.**

*\*Please note: The markings are for LHD applications. RHD applications will be reversed.*



**Driver Side Spring Seat Installed**



**Pass. Side Spring Seat Installed with Coil**

# ROCK KRAWLER

S U S P E N S I O N

- 18) Install the Rock Krawler rear coil springs. Make sure to put the closer wound coils go up and the end coil winding is sitting in the top spring seat properly. **Please note:** The top spring seats are indexed as well with a pin to set their orientation. This too must be correct.
- 19) **Slowly start to compress the suspension and attach the rear track bar to the supplied track bar bracket.** If included or purchased separately, set the Rock Krawler Rear Track bar to length. Install the fixed Anti-Wobble joint to the frame using the OEM hardware. The Zerk fitting faces down for ease of greasing. The 7/8" Shank heim joint (RK03426) goes to the newly supplied rear track bar bracket using the supplied 14mm x 80mm bolt, washers and nylok nut.

**\*Please Note:** The offset in the bar (bend) goes around the rear differential.

- 20) Install the rear shocks using the OEM hardware. Refer to front notes if needed.
- 21) If purchased separately, or if you bought RK shocks and they were included in the system, install the RK fabricated rear bump stops. Our rear fabricated bump stops mount to the factory bump stop pad using the supplied 3/8 x 3/4 bolts, washers, and nylok nuts. Make sure the bumps stop angles to the front of the vehicle as shown in the photo below. **For 2.5" lifts we recommend just the steel base. For 3.5" lifts we recommend a single 1" rubber pad stacked on top of the mounting pad. For 4.5" lifts we recommend two 1" rubber pads on top of the mounting pad.** We recommend having the rubber spacer moved to the back of the pad as far as possible for starters. We also recommend you cycle the suspension to ensure the bump stops are making contact correctly and you have the proper amount of bump installed to protect all components.



- 22) **Adventure System:** Install the Supplied fixed Rear Sway Bar Links using the supplied 12mm x 70mm bolts, washers and nylok nuts. Please note: The extra thick washer goes under the head of the bolt as shown below. If you received the Pro double adjustable RK05185 links set to length to for you lift height. **2.5" Systems 11" / 3.5" Systems – 12" / 4.5" Systems – 13"**





# ROCK KRAWLER

S U S P E N S I O N

- A) The *pro link top* connection uses the supplied 12mm x 50 mm bolt, washers and nylok nut as shown below. Under the head of the bolt, there is a small washer and on each side of the sway bar link ball joint there is a washer and finally they are secured with the nylok nut. The large washer goes against the ball to retain the ball and socket joint.
- B) The *pro link bottom* connection uses the supplied 12mm x 50 mm bolt, washers and nylok nut as shown below. Under the head of the bolt, there is a small washer. Between the sway bar link ball joint and the OEM mounting bracket, there are two washers to provide extra clearance between the housing and the billet link end, then there is one more washer on the other side of the joint, then finally secured by the nylok nut.

**\*Please Note:** The Extra Thick Washer goes on the outside of the ball end so the housings and link assembly cannot slide off. Think of it as an extra-large retaining washer.

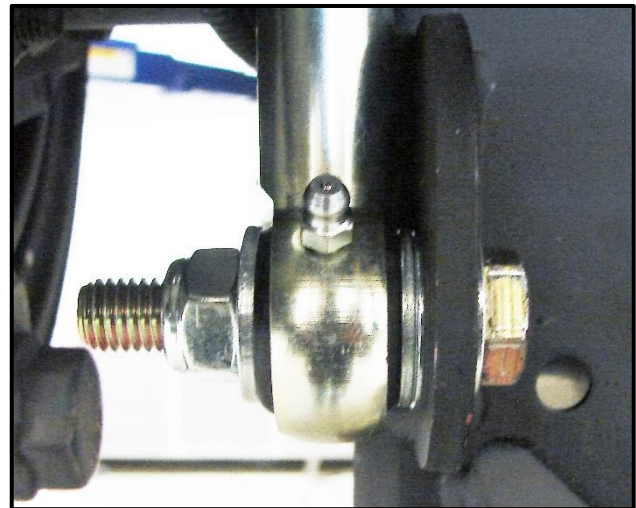
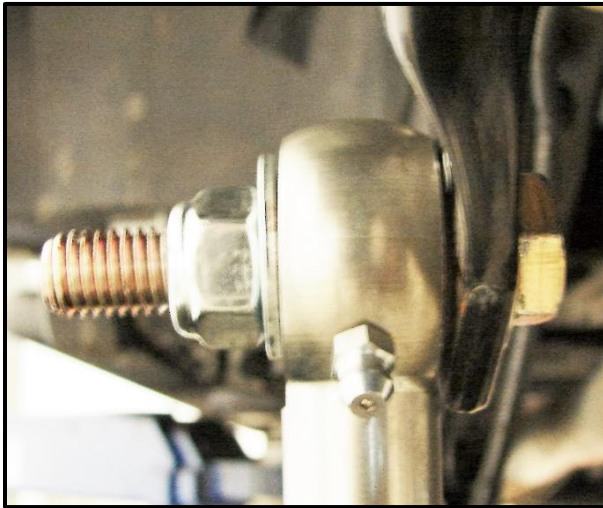

**Pro Rear Link Top Connection**

**Pro Rear Link Bottom Connection**

- 23) **Gently and easily** bend the rear brake line bracket on the axle toward the frame as shown. This will allow you plenty of travel in the brake lines for your systems.



**New Orientation for Rear Brake Line Brackets**

# ROCK KRAWLER

S U S P E N S I O N

24) Install the rear wheels and tires and lower the vehicle to the ground.

25) Tighten all mounting bolts at this time!

## Recommended Alignment Specs are as follows:

**2.5" Lift Height:** 5.0 to 6.5 degrees of Caster with a .2 to .4 Cross Caster Split (.2 to .4 degrees more caster on the pass. side than the driver's side.)

**3.5"/4.5" Lift Height:** 5.0 to 6.0 degrees of Caster with a .2 to .4 Cross Caster Split (.2 to .4 degrees more caster on the pass. side than the driver's side.)

**Tow:** Factory specifications

The rear pinion angle should be down 2 – 3 degrees from the driveshaft as shown below.



**\*Please Note:** If you do not have adjustable components, you will not be able to dial in the alignment or pinion angle settings so what you get is what you get...

# ROCK KRAWLER

## S U S P E N S I O N

### **A note about tires, wheels, tire pressure and how it effects ride quality:**

Tire and Wheel combinations at a given tire pressure have their own spring and damping rates associated with them. This plays a major part in ride quality and off-road performance. The stock tire pressure settings on your Wrangler are based on stock C rated light duty tires on 17" wheels. Larger aftermarket tires typically have a much firmer side wall than the stock ones, thus increasing the spring rate and decreasing the damping rate associated with the tires themselves. Going from a C to a D or E rated tire also amplifies this effect. Increasing wheel diameters cuts down on the sidewall size of the tire; for example, going from a 17" wheel to a 20" to 22" wheels will increase the spring rate and decrease the damping rate of the tire and wheel combination. As you increase tire strength and wheel size it is common to have to reduce the tire pressures in order to make your aftermarket tire and wheel combination feel like a stock tire and wheel combination. **Choose pressures wisely and safely! This is one part of your suspension tuning you can do on your own.**

**Before hitting the pavement or the trails be sure to make sure the control arms are oriented properly, all spherical joints (heim joints and Krawler Joints) are oriented correctly to allow for maximum movement without bind, and all jam nuts have Loctite on them and are tight. Make sure the axles are properly centered, pinion angles are correct, there is proper slack in ABS lines, and all lines are properly routed. Go back over all your hardware and make sure each connection is tightened to its proper torque spec. Check your vehicles articulation and ensure that no moving parts contact or interfere with any other components throughout the travel (brake lines, shocks, coils, sway bar links). Also check to see if at full flex your coil spring losses tension, if so, you may want to look into a limit straps. You may need to look at bump stops depending on what shocks you choose to run.**

**Congratulations, you have just finished installing your Rock Krawler Suspension System! Your Jeep is now free to roam about the country.**



## **Common Service Parts Listings:**

**\*\*Grease only needed for Track bars and sway bar links**

**Rock Krawler 000 Grade Grease – 3 oz tube – RK05494 For Systems Before Jan 1, 2020**

**Grade 1 Grease such as Mobil Grease – Mobilux EP1 [NLGI 1] or equivalent can be used for Systems After Jan 1, 2020.**

### **Front and Rear Lower Control Arms Prior to 3/1/2021 Part Numbers RK06184 and RK06190**

**Pro Flex Bushings – RK04838K – Requires Large Joint Tool – RK04484**

### **Front Lower Control Arms After to 3/1/2021 Part Numbers RK06779B (AS) and RK08194 (AXM)**

**Front Lower Control Arm Adventure Series fixed Joint – RK07404K**

**Adjustable Adventure Series Complete Adjustable Joint – RK08193 (1.25” shank)**

### **Rear Lower Control Arms After to 3/1/2021 Part Numbers RK06063B (AS) and RK08195 (AXM)**

**Rear Lower Control Arm Adventure Series fixed Joint – RK07403K**

**Rear Control Arm Adventure Series Complete Adjustable Joint – RK08192 (1.25” shank)**

### **Front and Rear Track Bars Prior to 1/1/2021 (RK06187 and RK06692/RK06692B)**

**Anti-Wobble Joint Bushings (Frame End) – RK07836K – Requires Small Joint Tool – RK04487**

**Replacement Heim Joints (Axle End) – RK03426 (7/8 Shank) – Optional New Misalignment Spacers – RK03428**

### **Front and Rear Track Bars After to 1/1/2021 (RK06187HD and RK06692B)**

**Anti-Wobble Joint Bushings (Frame End) – RK07836K – Requires Small Joint Tool – RK04487**

**Front Track Bar Replacement Heim Joint (Axle End) – RK07535 (1” Shank) – Optional New Misalignment Spacers – RK03428**

**Rear Track Bar Replacement Heim Joint (Axle End) – RK03426 (7/8” Shank) – Optional New Misalignment Spacers – RK03428**

### **Front Upper Control Arms:**

**Replacement Adventure Joint bushing – RK07415**

### **Rear Upper Control Arms:**

**Replacement Adventure Joint Bushing (fixed end) – RK07409**

**Replacement Adventure Joint Complete (threaded) – RK07427**

**Gen2 disconnects or Pro Rear Sway Bar End Links: Ball Center – RK04573**

# ROCK KRAWLER

S U S P E N S I O N

**For the Optional Coil Over Systems and or Upgrades and Rear Big Boy Shocks Please Do the Following!**

- 1) Remove the stock shock brackets from your Jeep. It's easiest to score the weld marks and cut the OEM shock tower into pieces. Be sure not to cut any important hoses or wires behind the shock tower. Re-paint any exposed areas with a durable coating after the towers have been removed.



**Passengers Side Bracket Removed**

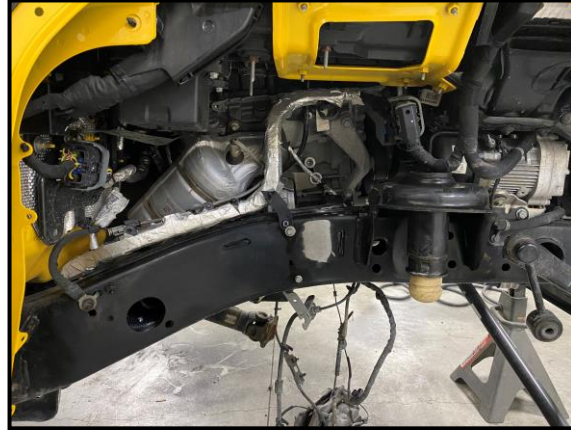

**Drivers Side Bracket Removed**

- 2) Make sure to bend the driver's side bracket upwards before test fitting your coil over towers. This will stop the new towers from hitting.



- 3) Test-fit your coil over brackets as shown below. Clamp the mount about the oval frame side hole and center punch one of the 1/2" holes. Remove the tower and drill out one 1/2" hole on the side of the frame. After that, center the coil over mount on the spring tower and drill three 7/16" holes in the spring tower.

# ROCK KRAWLER

S U S P E N S I O N



- 4) Bolt the tower down. The two frame connections get  $\frac{1}{2}$ " x 1.25" bolts, two washers and a locknut each. The three spring tower connections get  $\frac{7}{16}$ " screws, two washers and one locknut each.
- 5) Next, remove the OEM bottom shock mount from the frame. You may need to use a Dremel in order to get the last of the mount off the axle cleanly.
- 6) Set the caster on the axle to 5 degrees as shown below before welding on the new lower coil over mounts. Keep the axle at that angle for the proceeding steps. Measure from the top ball joint surface.



- 7) Grind the powder coat off the new mounts in all applicable weld surfaces. Measure  $\frac{3}{4}$ " away from the inner C for Rubicon models as shown below. For Non-Rubi models, bring the new mount as close to the axle C as possible. This is because JL Rubi Axle WMS is 68.00"/ JL Sport/Sahara WMS is 66.50". For 73" WMS Dynatrac 60's measure 1" away from the inner C.

# ROCK KRAWLER

S U S P E N S I O N

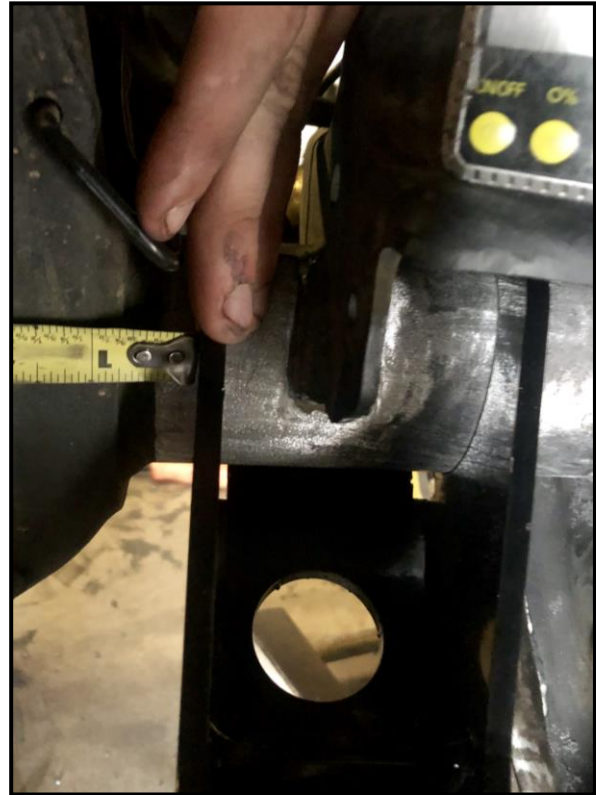

**\*Please Note:** For some axle housings you may have to trim the OEM spring bucket at the axle for proper coil over shock clearance.

- 8) While the axle caster is set to **5 Degrees**, set the top surface of the lower coil over mounts to **0 Degrees**. Make sure the outward spacing from the "C" and angle of zero are correct before you weld these mounts. After, apply a durable finish of your choice to the bracket to prevent corrosion.

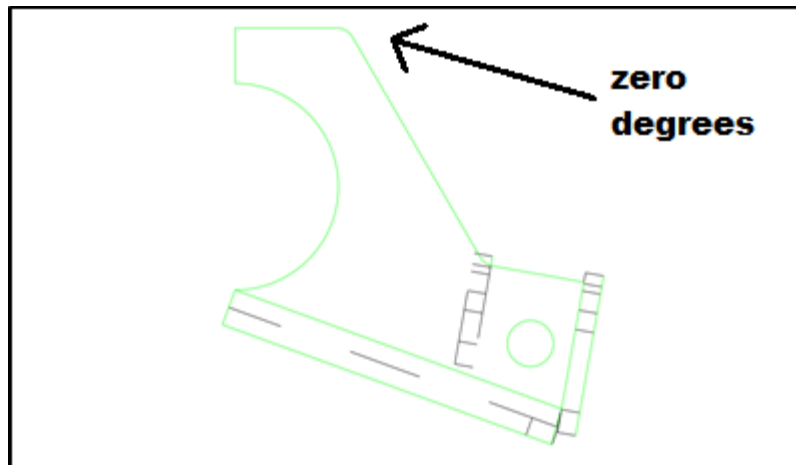

- 9) Test fit the coil over into the vehicle and confirm clearance and fitment.
- 10) Install coil over with minimal preload and transition rings in a spot where the slider won't contact. Place the supplied spacer on the top coil over connection on the inside of the bearing. Then secure the top connection with a  $\frac{1}{2}$ " x 3.25" bolt with a washer on each side and locknut on the backside. Then place the  $\frac{1}{2}$ " x 2.75" bolt through the bottom connection with a washer on each side, locknut on the back. **\*Please Note:** These mounts are designed as large shock mounts as well as coilover mounts. The spacer simply makes this coilover compatible.

# ROCK KRAWLER

S U S P E N S I O N



- 11) Adjust coil overs after a 50-mile mild break in period.
- Unload the vehicle weight from shock
  - Bring down Preload adjuster to desired ride height. Approximately 3" from the bottom of the top cap to the top of the ring for 4.5" of lift
  - Drive another 50 miles
  - Using a screwdriver or tool of your choice adjust the transition rings to 1" above the black nylon slider
  - Drive another 50 miles
  - Make final adjustments based on driver preferences. Moving the transition rings closer to the nylon slider will make the coil over get into the stiffer rate quicker and more often.



# ROCK KRAWLER

S U S P E N S I O N

The passenger's side orientation for rear remote reservoir shocks is shown below. Make sure to orient the bushings as shown in the diagram below. Ensure the reservoirs are oriented backwards.

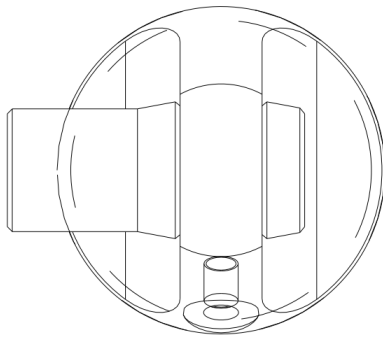

Top View – Passengers Side Orientation